

Metallized Polypropylene Film Capacitors

Type: **ECWF(A)**

Designed for high frequency and current applications.

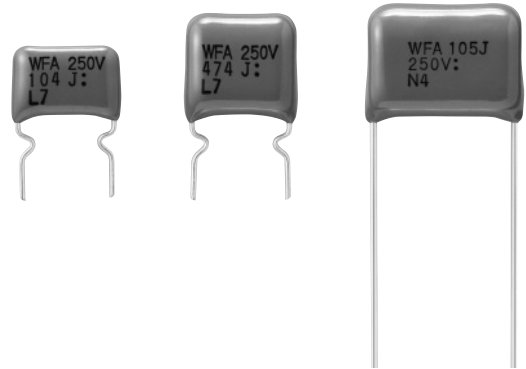

■ Features

- Small size
- Excellent frequency characteristics
- Low loss
- Low Hum Sound Noise
- 85 degree C , 85%RH , 500VDC , 500 hours (630VDC)
- RoHS directive compliant

■ Recommended Applications

- 250VDC,630VDC:High frequency and high current circuits
- 450VDC:Active filter circuits

■ Explanation of Part Numbers

● 250VDC,450VDC (Bulk)

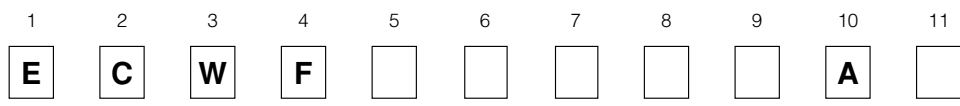

Products code Dielectric & construction Rated voltage Capacitance Cap. Tol. Suffix Suffix

2	250 VDC	H	±3 %
		J	±5 %
2W	450 VDC	J	±5 %
		K	±10 %

Suffix	Lead form
Blank	Straight
B	Crimped Lead
Q	Crimped Lead
C	Cut lead

● 250VDC,450VDC (Odd Size Taping)

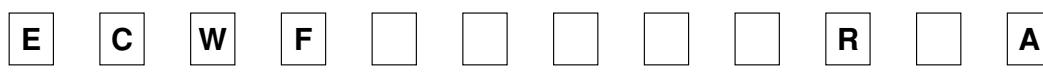

Products code Dielectric & construction Rated voltage Capacitance Suffix Cap. Tol. Suffix

● 630VDC (Bulk, Odd Size Taping)

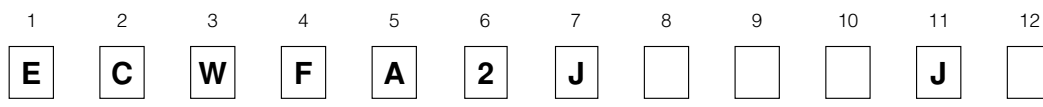

Products code Dielectric & construction Rated voltage Capacitance Cap. Tol. Suffix

2J	630 VDC	J	±5 %
----	---------	---	------

Suffix	Lead form
Blank	Straight
B	Crimped Lead
Q	Crimped Lead
C	Cut lead
4	Odd size taping

■ Specifications

Category temp. range (Including temperature-rise on unit surface)	-40 °C to +105 °C	
Rated voltage	250 VDC	
	450 VDC (Derating of rated voltage by 1.25%/°C at more than 85°C) Peak to peak voltage applied on the capacitor should be less than 240Vp-p, and zero to peak voltage should be less than 450V.	
	630 VDC (Derating of rated voltage by 1.0%/°C at more than 85°C)	
Capacitance range	250 VDC	0.1 μF to 6.8 μF
	450 VDC	0.1 μF to 4.7 μF
	630 VDC	0.1 μF to 2.2 μF
Capacitance tolerance	250 VDC	±3 % (H), ±5 % (J)
	450 VDC	±5 % (J), ±10 % (K)
	630 VDC	±5 % (J)
Withstand voltage	Between terminals: Rated voltage (VDC) × 150 % 60 s	
Dissipation factor (tan δ)	tan δ ≤ 0.1 % (20 °C, 1 kHz)	
Insulation resistance (IR)	250 VDC	C ≤ 0.33 μF : IR ≥ 9,000 MΩ C > 0.33 μF : IR ≥ 3,000 MΩ · μF (20 °C, 100 VDC, 60 s)
	450 VDC	C ≤ 0.33 μF : IR ≥ 30,000 MΩ C > 0.33 μF : IR ≥ 10,000 MΩ · μF (20 °C, 100 VDC, 60 s)
	630 VDC	C ≤ 0.33 μF : IR ≥ 9,000 MΩ C > 0.33 μF : IR ≥ 3,000 MΩ · μF (20 °C, 500 VDC, 60 s)

* In case of applying voltage in alternating current (50 Hz or 60 Hz sine wave) to a capacitor with DC rated voltage, please refer to the page of "Permissible voltage (R.M.S) in alternating current corresponding to DC rated voltage".

Metallized Film

■ Dimensions in mm (not to scale)

(Dimensions : mm)

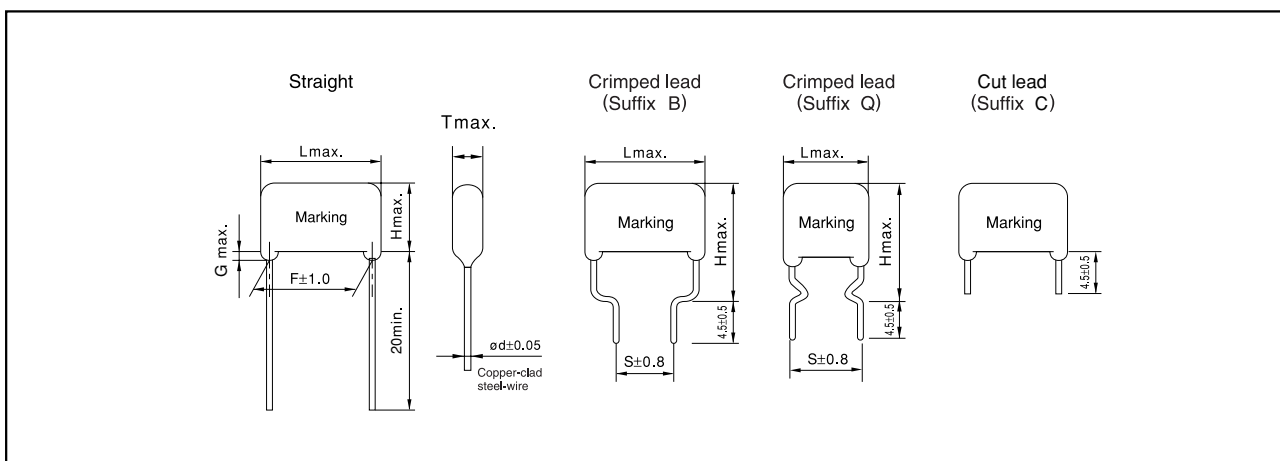

■ Packaging Specification for Bulk Package

Packing quantity: 100 pcs./bag

■ Taping Specifications for Automatic Insertion

● Taping style

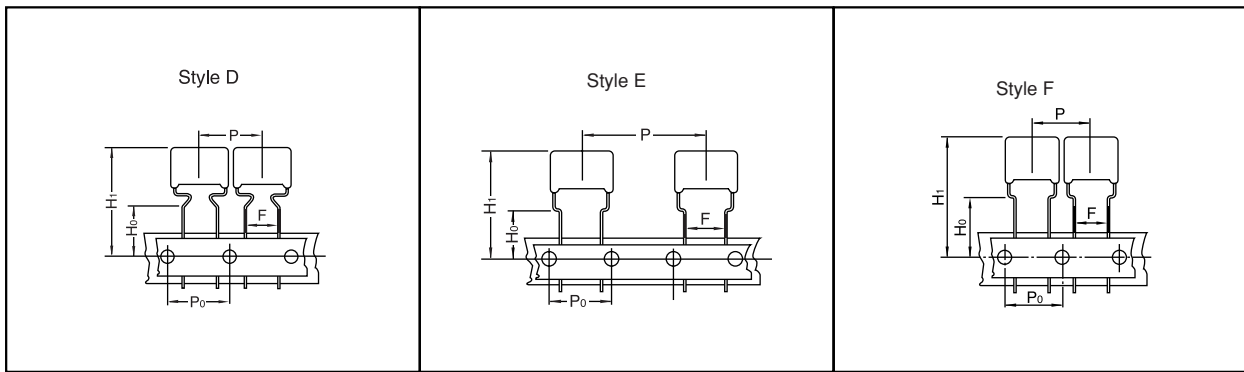

*Refer to the page of taping specifications.

● Packaging Specifications

Type	Rated voltage.	Cap. range (μF)	Taping style						Packing	suffix
			AD	AS	B	C	D	E		
ECWF(A)	250 VDC	0.10 to 0.47					○		Ammo	R() A
		0.56 to 3.9					○			
	450 VDC	0.10 to 0.47					○			
		0.56 to 2.2					○			
630 VDC	0.10 to 0.68					○		J4		

● Lead Spacing

Style	Lead Spacing
D	7.5 mm
E	7.5 mm
F	7.5 mm

■ Rating, Dimensions & Quantity/Ammo Box

● Type ECWF(A) Rated voltage : 250 VDC

Part No.	Cap. (μF)	Dimensions (mm)										Min. order Q'ty	
		L _{max}	T _{max}	H _{max}			F	S		G _{max}	ød	Taping 7.5mm	Bulk
				Straight	Crimped lead (Suffix B)	Crimped lead (Suffix Q)		Straight	Crimped lead (Suffix B)				
ECWF2104□A()	0.10	13.0	5.0		14.1	14.1		7.5	10.0		0.6	1300	500
ECWF2124□A()	0.12	13.0	5.3		14.4	14.4		7.5	10.0		0.6	1200	
ECWF2154□A()	0.15	13.0	5.6		14.7	14.7		7.5	10.0		0.6	1100	
ECWF2184□A()	0.18	13.0	5.9		15.1	15.1		7.5	10.0		0.6	1000	
ECWF2224□A()	0.22	13.0	6.3		15.4	15.4		7.5	10.0		0.6	900	
ECWF2274□A()	0.27	13.0	6.8		15.9	15.9		7.5	10.0		0.6	800	
ECWF2334□A()	0.33	13.0	7.3		16.4	16.4		7.5	10.0		0.6	700	
ECWF2394□A()	0.39	13.0	7.8		16.9	16.9		7.5	10.0		0.6	600	
ECWF2474□A()	0.47	13.0	8.4		17.6	17.6		7.5	10.0		0.6	500	
ECWF2564□A()	0.56	18.1	6.9		16.4	18.4		7.5	15.0		0.8	400	
ECWF2684□A()	0.68	18.1	7.4		17.0	19.0		7.5	15.0		0.8	300	
ECWF2824□A()	0.82	18.1	8.0		17.6	19.6		7.5	15.0		0.8	200	
ECWF2105□A()	1.0	18.1	8.5	13.3	18.3	20.3	15.0	7.5	15.0	1.5	0.8	300	
ECWF2125□A()	1.2	18.8	9.5	14.6	19.6	21.6	15.0	7.5	15.0	1.5	0.8	200	
ECWF2155□A()	1.5	18.8	10.5	15.6	20.6	22.6	15.0	7.5	15.0	1.5	0.8	300	
ECWF2185□A()	1.8	18.8	11.4	16.5	21.5	23.5	15.0	7.5	15.0	1.5	0.8	200	
ECWF2225□A()	2.2	18.8	12.6	17.6	22.6	24.6	15.0	7.5	15.0	1.5	0.8	300	
ECWF2275□A()	2.7	23.8	11.4	17.2	22.2	24.2	20.0	12.5	20.0	1.5	0.8	200	
ECWF2335□A()	3.3	23.8	12.5	18.3	23.3	25.3	20.0	12.5	20.0	1.5	0.8	—	
ECWF2395□A()	3.9	23.8	13.5	19.3	24.3	26.3	20.0	12.5	20.0	1.5	0.8	—	
ECWF2475□A()	4.7	23.8	14.8	20.6	25.6	27.6	20.0	12.5	20.0	1.5	0.8	—	
ECWF2565□A()	5.6	23.8	16.2	21.9	26.9	28.9	20.0	12.5	20.0	1.5	0.8	—	
ECWF2685□A()	6.8	23.8	17.8	23.5	28.5	30.5	20.0	12.5	20.0	1.5	0.8	—	

↑ Suffix for lead crimped
 — Capacitance tolerance code

Design, Specifications are subject to change without notice. Ask factory for technical specifications before purchase and/or use. Whenever a doubt about safety arises from this product, please inform us immediately for technical consultation without fail.

■ Rating, Dimensions & Quantity/Ammo Box

● Type ECWF(A) Rated voltage : 450 VDC

Part No.	Cap. (μ F)	Dimensions (mm)										Min. order Q'ty							
		L _{max}	T _{max}	H _{max}			F	S		G _{max}	ϕ d	Taping 7.5mm	Bulk						
				Straight	Crimped lead (Suffix B)	Crimped lead (Suffix Q)		Crimped lead (Suffix B)	Crimped lead (Suffix Q)										
ECWF2W104□A()	0.10	13.0	5.1	—	14.3	14.3	—	7.5	10.0	1.5	0.6	1200	500						
ECWF2W124□A()	0.12	13.0	5.4											14.5	14.5	7.5	10.0	1.5	0.6
ECWF2W154□A()	0.15	13.0	5.7											14.9	14.9	7.5	10.0	1.5	0.6
ECWF2W184□A()	0.18	13.0	6.1									15.2		15.2	7.5	10.0	1.5	0.6	1000
ECWF2W224□A()	0.22	13.0	6.5									15.6		15.6	7.5	10.0	1.5	0.6	
ECWF2W274□A()	0.27	13.0	7.0									16.1		16.1	7.5	10.0	1.5	0.6	
ECWF2W334□A()	0.33	13.0	7.6									16.7		16.7	7.5	10.0	1.5	0.6	800
ECWF2W394□A()	0.39	13.0	8.1									17.2		17.2	7.5	10.0	1.5	0.6	
ECWF2W474□A()	0.47	13.0	8.7									17.9		17.9	7.5	10.0	1.5	0.6	
ECWF2W564□A()	0.56	18.1	7.0	11.5	16.5	18.5	15.0	7.5	15.0	1.5	0.8	400							
ECWF2W684□A()	0.68	18.1	7.5	12.1	17.1	19.1	15.0	7.5	15.0	1.5	0.8								
ECWF2W824□A()	0.82	18.1	8.2	12.7	17.7	19.7	15.0	7.5	15.0	1.5	0.8								
ECWF2W105□A()	1.0	18.1	9.3	12.6	17.6	19.6	15.0	7.5	15.0	1.5	0.8	300							
ECWF2W125□A()	1.2	18.8	9.7	14.7	19.7	21.7	15.0	7.5	15.0	1.5	0.8								
ECWF2W155□A()	1.5	18.8	10.7	15.8	20.8	22.8	15.0	7.5	15.0	1.5	0.8								
ECWF2W185□A()	1.8	18.8	11.6	16.7	21.7	23.7	15.0	7.5	15.0	1.5	0.8	200							
ECWF2W225□A()	2.2	18.8	12.8	17.9	22.9	24.9	15.0	7.5	15.0	1.5	0.8								
ECWF2W275□A()	2.7	26.3	10.6	16.5	21.5	23.5	22.5	15.0	22.5	1.5	0.8			—					
ECWF2W335□A()	3.3	26.3	11.7	17.5	22.5	24.5	22.5	15.0	22.5	1.5	0.8								
ECWF2W395□A()	3.9	26.3	12.6	18.4	23.4	25.4	22.5	15.0	22.5	1.5	0.8								
ECWF2W475□A()	4.7	26.3	13.8	19.6	24.6	26.6	22.5	15.0	22.5	1.5	0.8								

↑ Suffix for lead crimped
 — Capacitance tolerance code

● Type ECWF(A) Rated voltage : 630 VDC

Part No.	Cap. (μ F)	Dimensions (mm)										Min. order Q'ty		
		L _{max}	T _{max}	H _{max}			F	S		G _{max}	ϕ d	Taping 7.5mm	Bulk Straight	Bulk Crimped lead
				Straight	Crimped lead (Suffix B)	Crimped lead (Suffix Q)		Crimped lead (Suffix B)	Crimped lead (Suffix Q)					
ECWFA2J104J()	0.10	18.2	5.2	10.4	15.4	15.4	15.0	7.5	15.0	1.5	0.6	600	1000	1000
ECWFA2J124J()	0.12	18.2	5.5	10.8	15.8	15.8	15.0	7.5	15.0	1.5	0.6			
ECWFA2J154J()	0.15	18.2	6.0	11.2	16.2	16.2	15.0	7.5	15.0	1.5	0.6			
ECWFA2J184J()	0.18	18.2	6.5	11.7	16.7	16.7	15.0	7.5	15.0	1.5	0.6	500		
ECWFA2J224J()	0.22	18.2	7.1	12.3	17.3	17.3	15.0	7.5	15.0	1.5	0.6			
ECWFA2J274J()	0.27	18.2	7.8	12.9	17.9	17.9	15.0	7.5	15.0	1.5	0.6			
ECWFA2J334J()	0.33	18.2	8.5	13.6	18.6	18.6	15.0	7.5	15.0	1.5	0.6	400		
ECWFA2J394J()	0.39	18.2	9.2	14.3	19.3	19.3	15.0	7.5	15.0	1.5	0.6			
ECWFA2J474J()	0.47	18.2	10.0	15.1	20.1	20.1	15.0	7.5	15.0	1.5	0.6			
ECWFA2J564J()	0.56	18.2	10.9	16.0	21.0	21.0	15.0	7.5	15.0	1.5	0.6	300		
ECWFA2J684J()	0.68	18.1	12.0	17.1	22.1	22.1	15.0	7.5	15.0	1.5	0.6			
ECWFA2J824J()	0.82	26.0	10.1	15.3	20.3	22.3	22.5	15.0	22.5	1.5	0.8			
ECWFA2J105J()	1.0	26.0	11.1	16.2	21.2	23.2	22.5	15.0	22.5	1.5	0.8	200		
ECWFA2J125J()	1.2	26.0	12.1	17.2	22.2	24.2	22.5	15.0	22.5	1.5	0.8			
ECWFA2J155J()	1.5	26.0	13.5	18.6	23.6	25.6	22.5	15.0	22.5	1.5	0.8			
ECWFA2J185J()	1.8	26.0	14.8	19.8	24.8	26.8	22.5	15.0	22.5	1.5	0.8			
ECWFA2J225J()	2.2	26.0	16.3	21.4	26.4	28.4	22.5	15.0	22.5	1.5	0.8			

↑ Suffix for lead crimped

Design, Specifications are subject to change without notice. Ask factory for technical specifications before purchase and/or use. Whenever a doubt about safety arises from this product, please inform us immediately for technical consultation without fail.

ECWF (A) Type DC250V series (Metallized Polypropylene Film)

Electrical Characteristics <Typical Data >

Temperature Characteristics

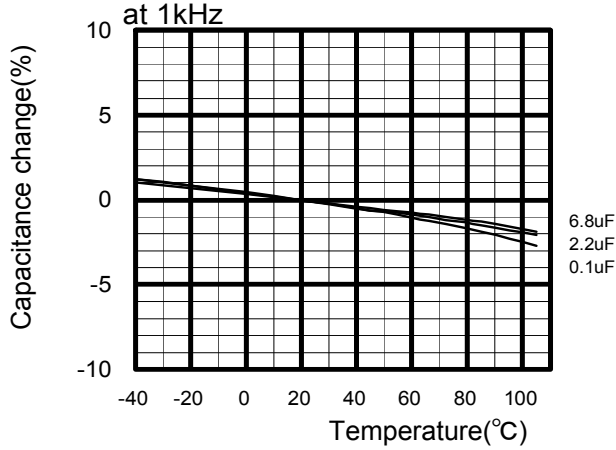

Frequency Characteristics

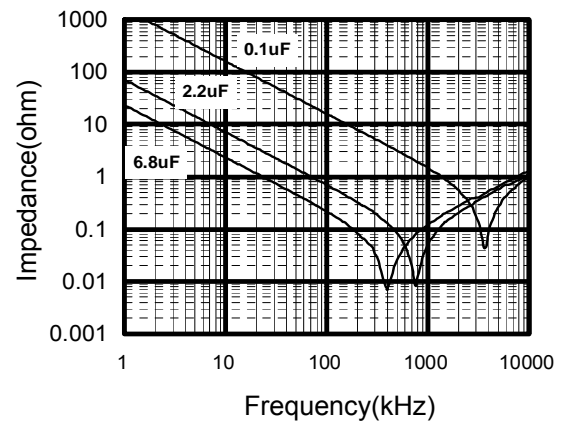
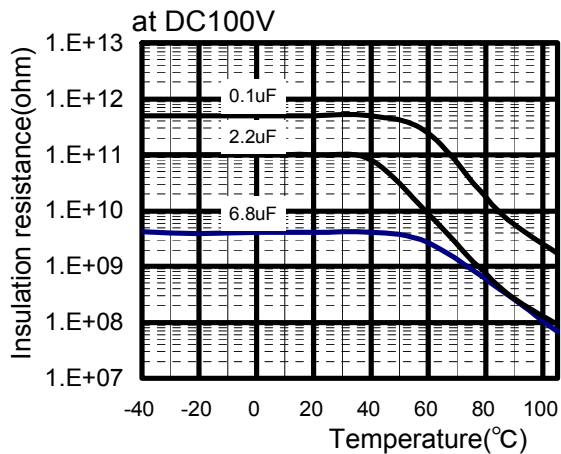
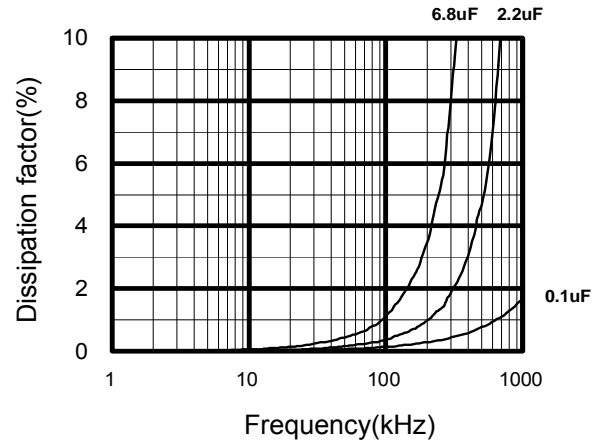
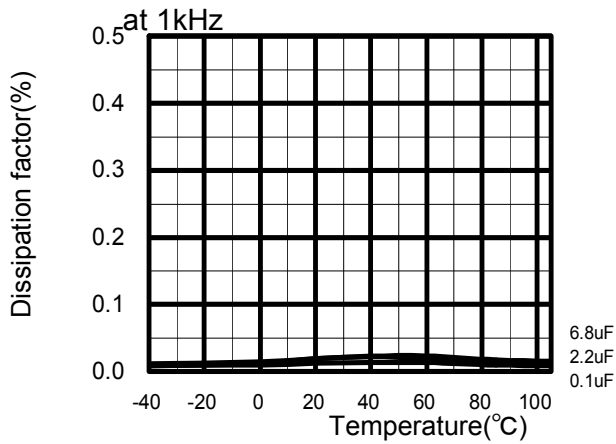
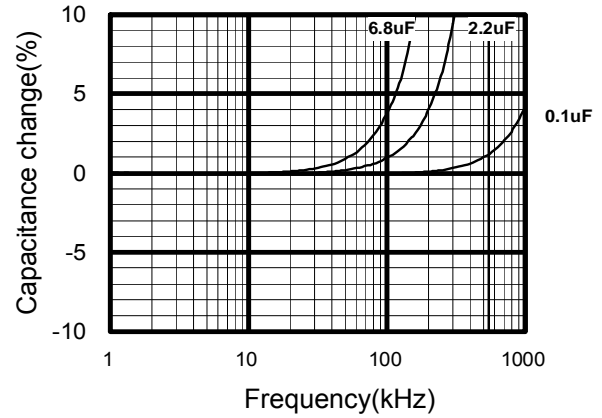

ECWF (A) Type DC250V series (Metallized Polypropylene Film)

Applicable Specifications

Permissible Current

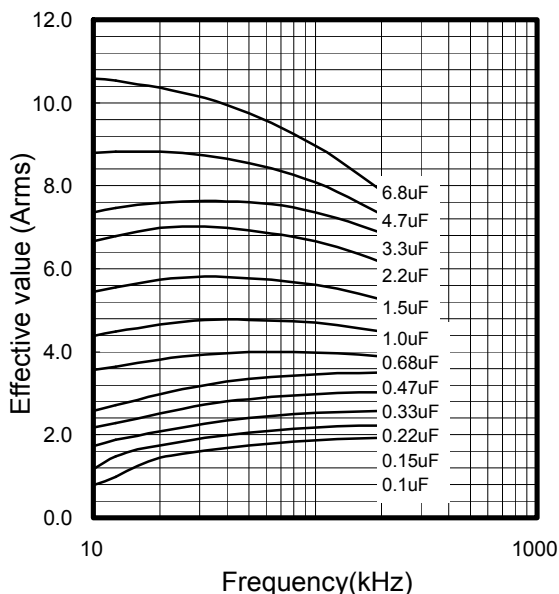

Permissible Current Derating by Temperature

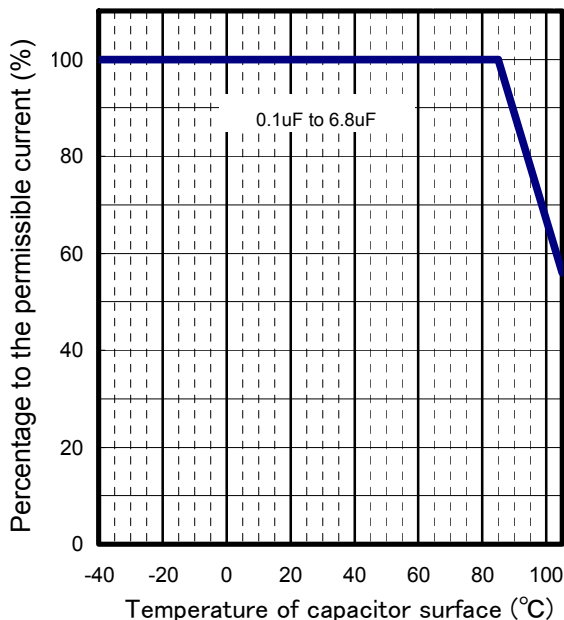

Pulse Handling Capability (dv/dt)
(Max 10000cycles)

Rated Voltage	Capacitance (μF)	Code	dV/dt (V/μs)	Current (A0-P)
DC 250V	0.10	104	135	13.5
	0.15	154		20.2
	0.22	224		29.7
	0.33	334		44.5
	0.47	474		63.4
	0.68	684		55.7
	1.00	105	82	82.0
	1.50	155		123.0
	2.20	225		180.4
	3.30	335	57	188.1
	6.80	685		387.6

Voltage Derating by Temperature

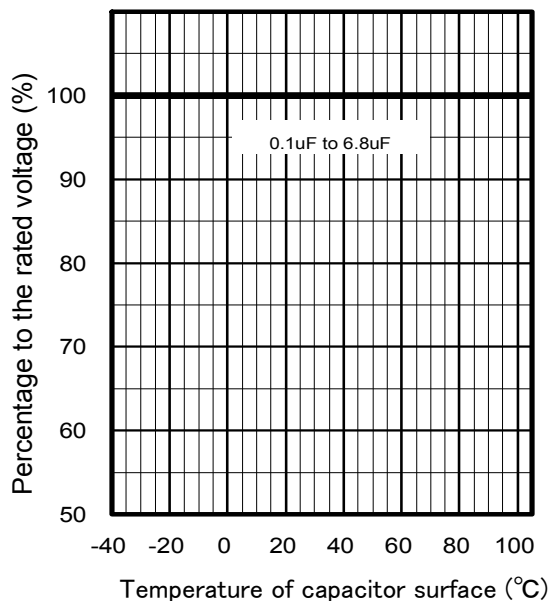

*Please consult Panasonic if your condition exceeds the above
 *P When you use this product, peak voltage must not exceed DC rated voltage.
 *The current(0-P) value is calculated using nominal capacitance.

ECWF (A) Type DC450V series (Metallized Polypropylene Film)

Electrical Characteristics <Typical Data >

Temperature Characteristics

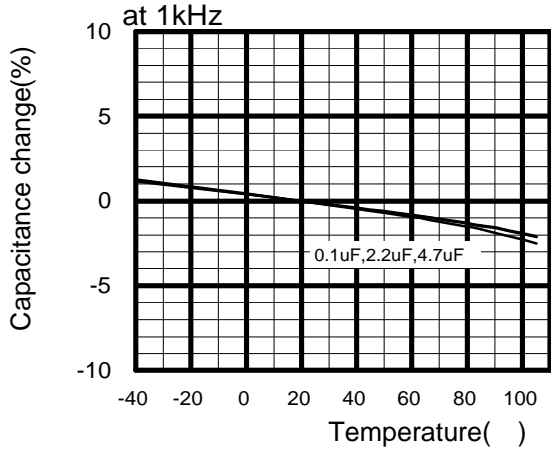

Frequency Characteristics

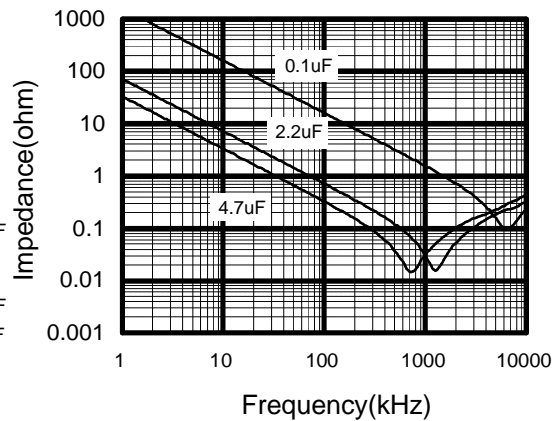
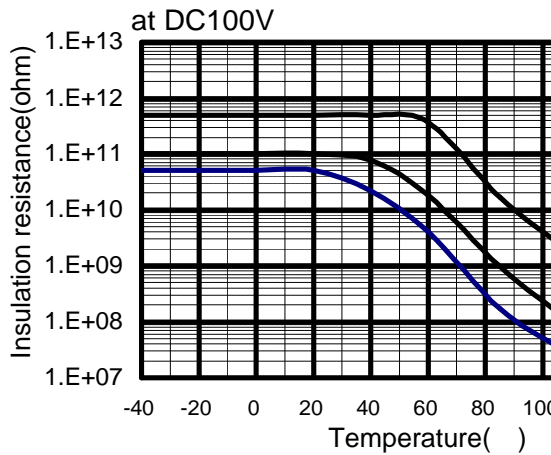
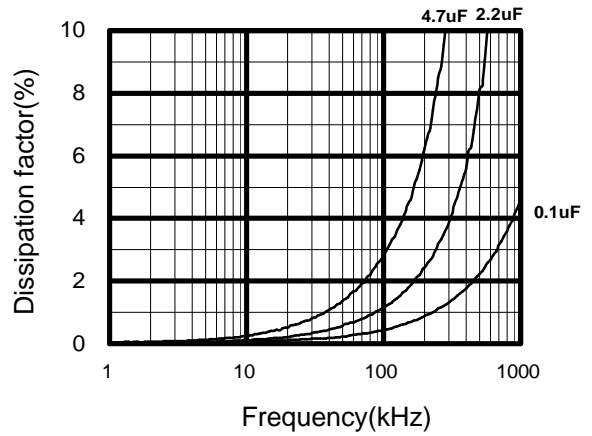
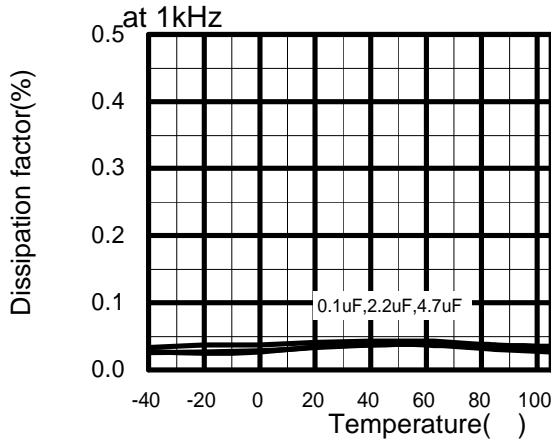
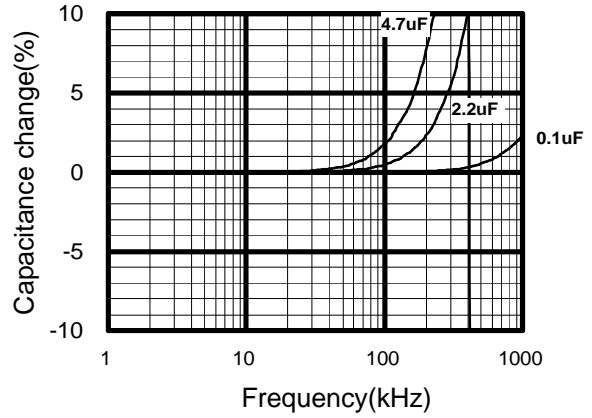

ECWF (A) Type DC450V series (Metallized Polypropylene Film)

Applicable Specifications

Permissible Current

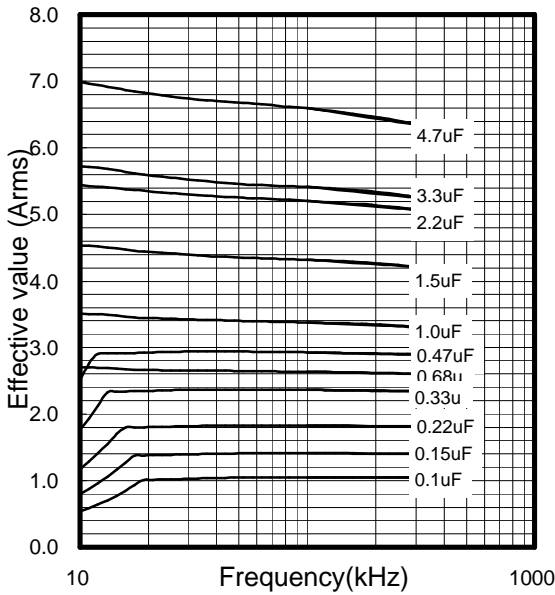

Permissible Current Derating by Temperature

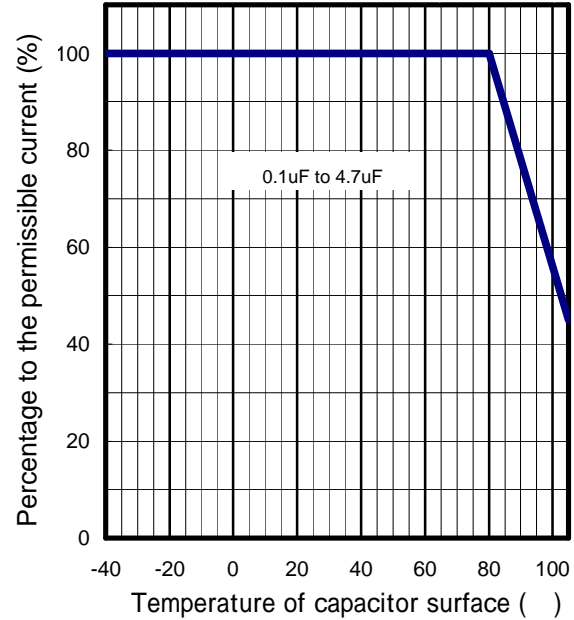

Pulse Handling Capability (dv/dt)
(Max 10000cycles)

Rated Voltage	Capacitance (μF)	Code	dV/dt (V/μs)	Current (A0-P)
DC 450V	0.10	104	41.6	4.2
	0.15	154		6.2
	0.22	224		9.2
	0.33	334		13.7
	0.47	474		19.6
	0.68	684	24.3	16.5
	1.00	105		24.3
	1.50	155		36.4
	2.20	225	14.3	53.4
	2.20	335		47.2
4.70	475		67.3	

Voltage Derating by Temperature

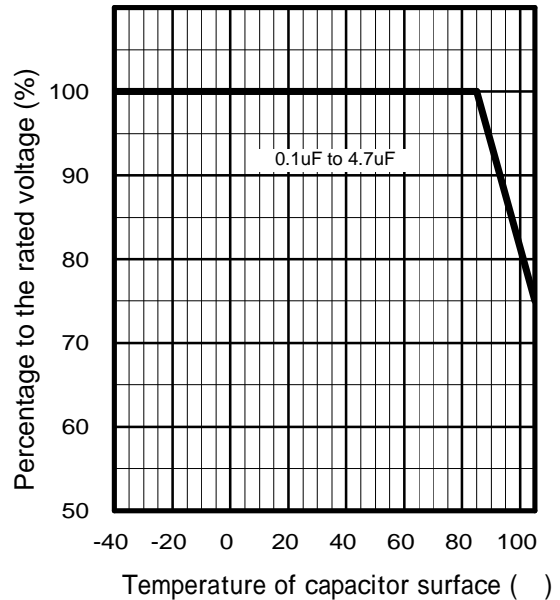

*Please consult Panasonic if your condition exceeds the above
 *P When you use this product, peak voltage must not exceed DC rated voltage.
 *The current(0-P) value is calculated using nominal capacitance.

ECWFA Type DC630V series (Metallized Polypropylene Film)

Electrical Characteristics <Typical Data >

Temperature Characteristics

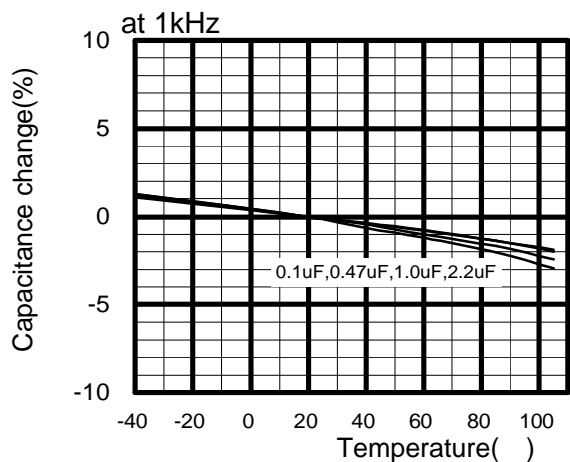

Frequency Characteristics

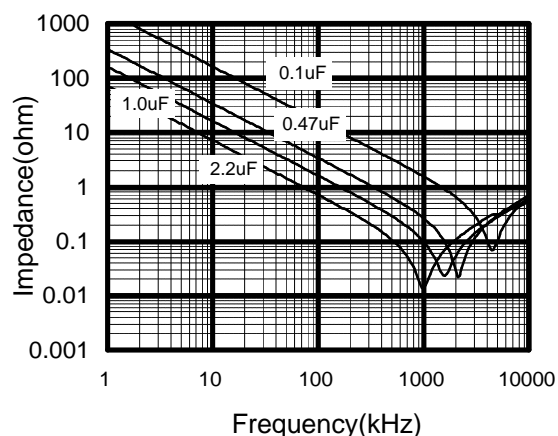
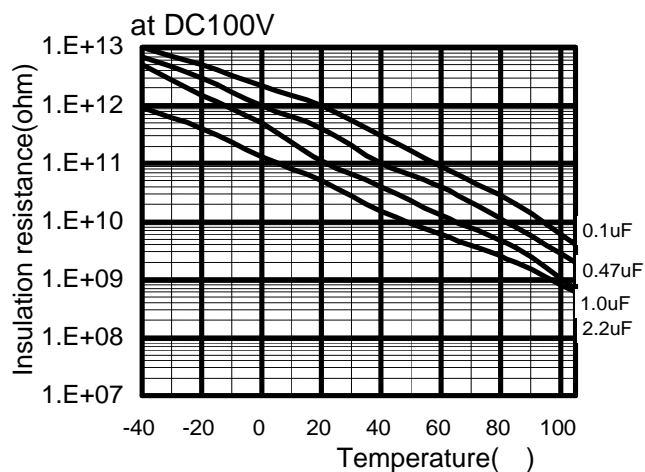
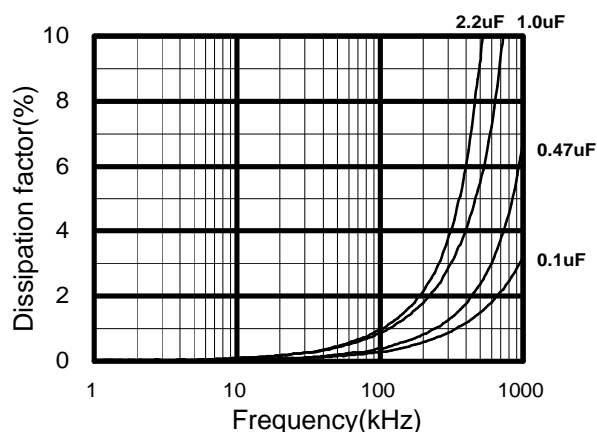
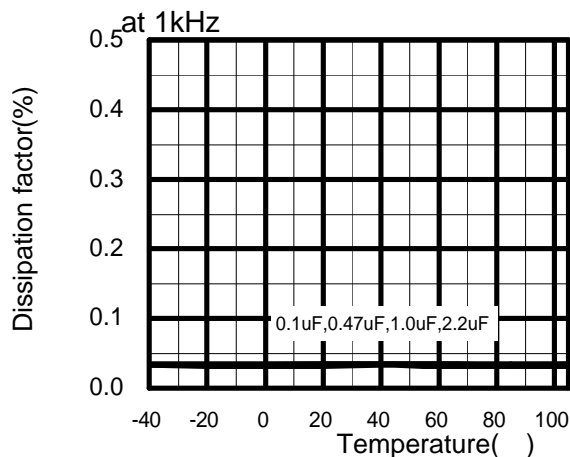
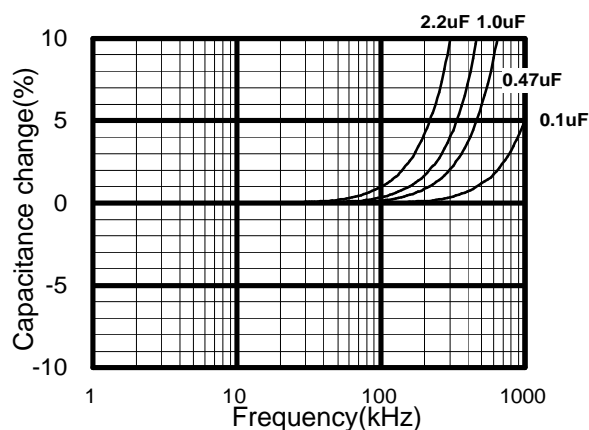

ECWFA Type DC630V series (Metallized Polypropylene Film)
Applicable Specifications

Permissible Current

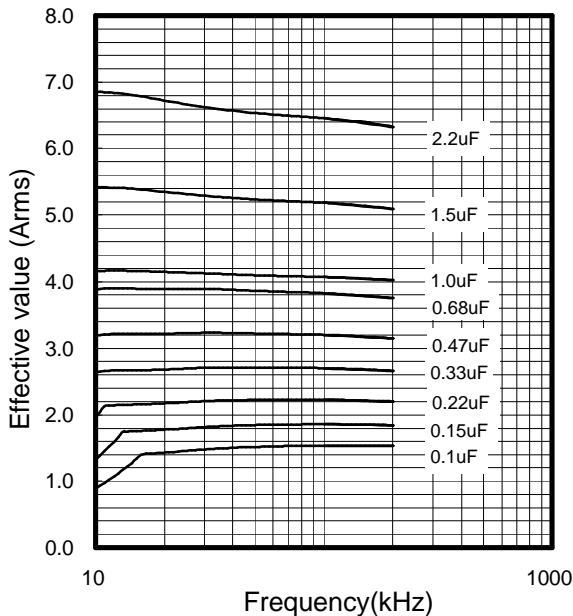

Permissible Current Derating by Temperature

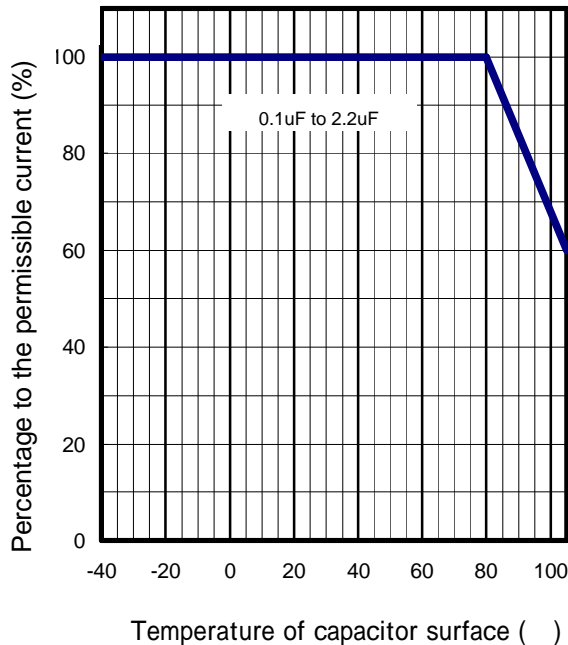

Pulse Handling Capability (dv/dt)
 (Max 10000cycles)

Rated Voltage	Capacitance (μF)	Code	dV/dt (V/μs)	Current (A0-P)
DC 630V	0.10	104	155	15.5
	0.12	124		18.6
	0.15	154		23.3
	0.18	184		27.9
	0.22	224		34.1
	0.27	274		41.9
	0.33	334		51.2
	0.39	394		60.5
	0.47	474		72.9
	0.56	564		86.8
	0.68	684		105.4
	0.82	824		65
	1.00	105	65.0	
	1.20	125	78.0	
	1.50	155	97.5	
	1.80	185	117.0	
2.20	225	143.0		

Voltage Derating by Temperature

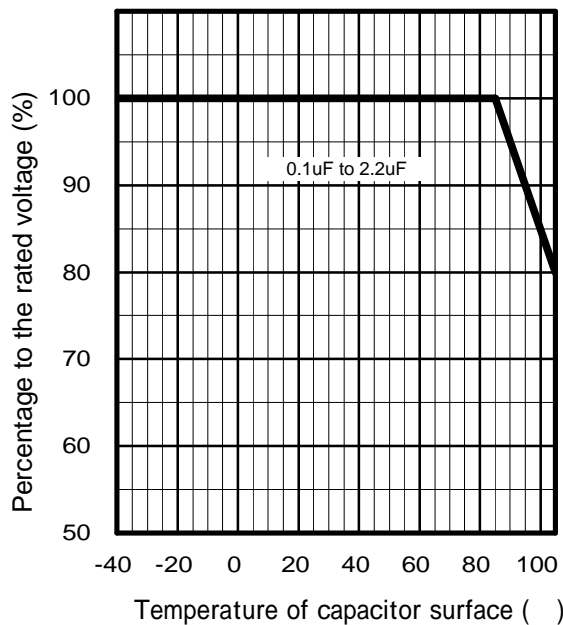

*Please consult Panasonic if your condition exceeds the above
 *When you use this product, peak voltage must not exceed DC rated voltage.
 *The current(I0-P) value is calculated using nominal capacitance.